



P516-271

CO-200

Offline lock user guide

Instructions for CO-Series offline locks

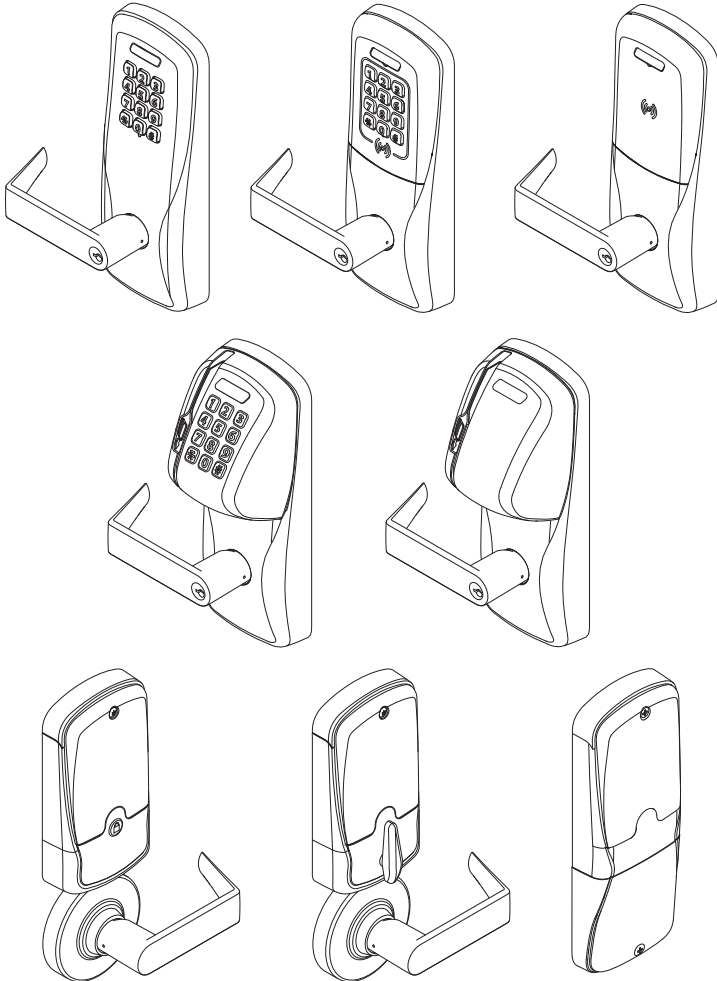

Para el idioma español, navegue hacia www.schlage.com/support.
Pour la portion française, veuillez consulter le site www.schlage.com/support.

Contents

Overview	3
Getting Started	4
Schlage Utility Software (SUS)	4
Construction access mode	5
Create the master construction credential - locks with card readers	5
Add construction access mode user credentials - locks with card readers	5
Cancel construction access mode	5
Locks with keypads	5
Manual lock programming	6
Credential types	6
Programming legend	6
Manual Programming Commands	7
Error codes	9
Test lock operation	10
Mechanical test	10
Test in factory default mode	10
Test in normal operation mode	10
Normal lock operation	10
Reset to factory defaults	11
Level 1 factory default reset	11
Level 2 factory default reset	11
Batteries	12
To install or replace alkaline batteries	12
Low battery indications	13
Battery failure modes	13
LED reference	13
Schlage button	13
Optional Inside Push Button (IPB)	13
Troubleshooting	14
FCC Statements	16

This product is compliant of UL 294 and ULCS319 standard. This product's compliance would be invalidated through the use of any add-on, expansion, memory or other module that has not yet been evaluated for compatibility for use with this UL Listed product, in accordance with the requirements of the Standards UL 294 and ULCS319. This product has been evaluated for ULC-S319 Class I.

Overview

The Schlage CO-200 is an off-line electronic lock in the CO-Series product line.

- This product is listed for UL 294 and ULCS319.
- The lock is configured to operate as Classroom/Storeroom function. Optional Office or Privacy functions are available.
- The lock is powered by four (4) AA batteries. See *Batteries* on page 12 for more information.
- Outside lever is normally locked.
- Inside lever always allows egress.
- The lock maintains an audit trail of events in the normal operating mode.
- The lock is configured using the Schlage Utility Software (SUS). See *Schlage Utility Software (SUS)* on page 4 for more information.

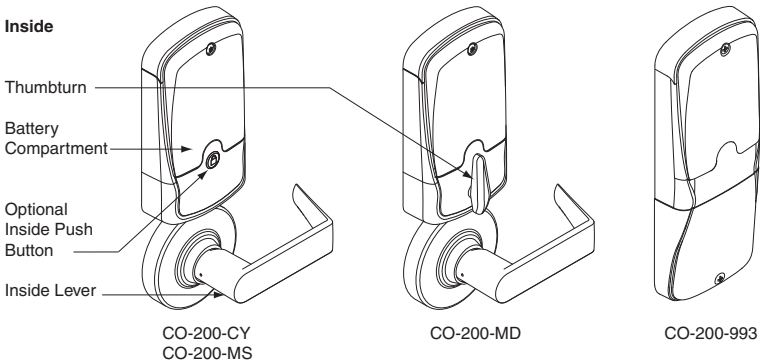
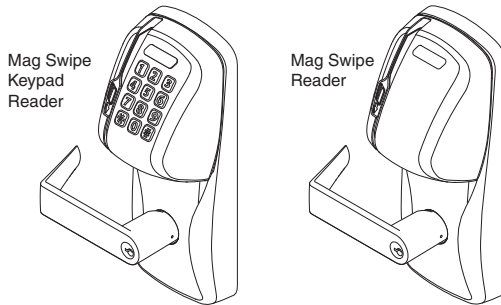
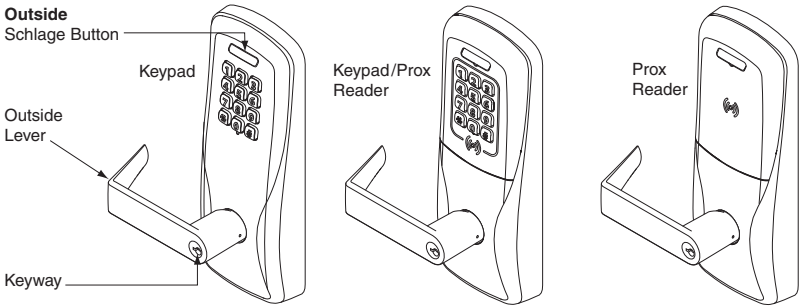

Getting Started

Follow these steps when setting up a new lock.

1. Install the lock. See the installation guide that came with the lock, or visit www.schlage.com/support, for more information.
2. Make sure the batteries are installed properly. See *Batteries* on page 12 for more information.
3. Before programming, the lock may be used in construction access mode. See *Construction access mode* on page 5 for more information. The lock should remain in construction access mode until you are ready to set up the rest of the system.
4. Test the lock for proper mechanical and electronic operation. See *Test lock operation* on page 10 for more information.
5. When ready to set up for normal use, remove factory default security settings, then program the user credentials. See *Manual lock programming* on page 6 for more information.
6. Consult the Schlage Utility Software (SUS) user guide for information about configuring the lock.
7. Familiarize yourself with the information in this guide.

Save this user guide for future reference.

Schlage Utility Software (SUS)

The Schlage Utility Software is used for programming and setup only.

The Schlage Utility Software (SUS) is used to configure locks. The SUS configures lock functions that cannot be configured with manual programming, and is used to transfer data files between the access control software and locks.

For more information about the SUS, see the SUS user guide.

Construction access mode

Construction access mode is used to allow access before the lock has been programmed, and for testing purposes.

- Enabled by default.
- The lock will remain in construction access mode until the mode is cancelled as described below.
- No audits are captured while lock is in construction access mode.

Create the master construction credential - locks with card readers

1. Press and hold the Schlage button while presenting a credential.
2. This credential becomes the master construction credential, and is used to program construction access.
3. The Schlage button will blink green on the left and right as confirmation.

After you have created the master construction credential, you can then use that card to add construction access mode user credentials.

- ① **The master construction credential will not grant access. It is used only to add additional credentials.**

Add construction access mode user credentials - locks with card readers

1. Present the master construction credential to the lock. The Schlage button will light.
2. Present the user credential to be added within twenty (20) seconds. The user credential will be added to the lock database.

- ① **Credentials added using the master construction credential will have normal 24/7 access.**

Cancel construction access mode

Construction access mode may be cancelled by one of the following methods:

- load a door file using the SUS
- reset the lock to factory settings (see *Reset to factory defaults on page 11* for more information).

When construction mode is cancelled, the master construction credential and all other credentials added using the master construction credential will no longer function.

Locks with keypads

In the factory default reset state, offline locks with keypads, with or without additional credentials, have a default PIN of 13579 and “#”, which can be used for installation, testing and construction access. To test, enter 13579 and “#”. The Schlage button will blink and the lock will unlock. The default PIN is automatically deleted when a new programming credential is created, construction credentials are created, or the lock is programmed with the Schlage Utility Software (SUS).

TIP

Use the same master construction credential for all the locks in the facility.

If you present the first card to a new lock to create the master construction credential and the card is not accepted, the lock has either been programmed or already has a master construction credential.

If the master construction credential cannot be located, or to put the lock back into construction access mode, reset the lock to factory settings. See *Reset to factory defaults* on page 11 for more information.

Manual lock programming

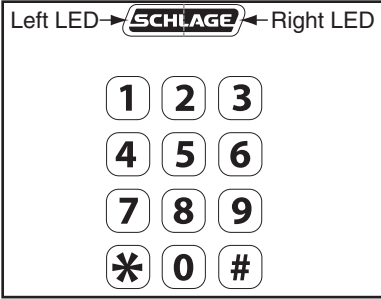

TIPS

The Schlage button has two different LEDs, one on the left and one on the right.

All locks have a default programming code of 97531 and “*”.

All locks have a default normal use code of 13579 and “#”.

When adding a card credential, the 3-6 digit code (PIN) entered prior to presenting the card becomes the credential reference number. This number can be used to delete a card without physically having the card. Keep a log of all issued credential reference numbers and codes for future reference.

Credential types

Credential type	Function	Description
Programming	Used to program the lock – does not unlock the lock	Five-digit code OR card
Normal Use	Unlocks the lock momentarily	PIN (3 - 6 digits) OR card
Normal Use +PIN		PIN (3 - 6 digits) AND card
Toggle	Changes the state of the lock from locked to unlocked, or vice versa, unless in a Freeze state	PIN (3 - 6 digits) OR card
Toggle +PIN		PIN (3 - 6 digits) AND card
Freeze	Freezes the lock in the current state – lock remains frozen until Freeze credential is presented again	PIN (3 - 6 digits) OR card
Freeze +PIN		PIN (3 - 6 digits) AND card
Pass-Through	Unlocks a lock momentarily, regardless of state	PIN (3 - 6 digits) OR card
Pass-Through +PIN	Overrides a lock in Freeze state	PIN (3 - 6 digits) AND card







Programming legend

Symbol	Description	TIP
[Programming Code] ¹	Five-digit code, identical to programming credential code listed in the Credential Types table.	Use the same programming code for all locks in the facility.
Programming Card	Programming Card, identical to programming credential card listed in the Credential Types table.	
[PIN]	Three- to six-digit code. A PIN can be any of the PIN code types listed in the Credential Types table. A PIN entered before a card credential becomes the credential reference number.	
*	Asterisk key on the keypad	
0 - 9	Number keys on the keypad	
	Schlage button	







¹ Programming codes such as 1-1-1-1-1 or 1-2-3-4-5 can be easily selected by non-authorized users and should not be used.

Manual Programming Commands

- ① Commands are confirmed by five alternating green blinks of the Schlage button.
- ① Programming mode will time out if no entry is made in 20-25 seconds. Time out is indicated by red blinks of the Schlage button, three left and nine right at the same time.
- ① The right LED on the Schlage button will blink green to indicate an incorrect entry. To interpret blink patterns, refer to *Error codes on page 9*.

Function	Press/Present	Wait for confirmation ¹
Change [Programming Code]	[Programming Code] * OR Programming Card	Wait for  to stop flashing between each step.
	7 *	
	New [Programming Code] *	
	New [Programming Code] *	
Change Programming Card	[Programming Code] * OR Programming Card	Wait for  to stop flashing between each step.
	7 *	
	New Programming Card	
Add Normal Use Credential	[Programming Code] * OR Programming Card	Wait for  to stop flashing between each step.
	3 *	
►New [PIN] *	
	* (for PIN only) OR New Card add another credential OR * to finish	
Add Normal Use +PIN Credential	[Programming Code] * OR Programming Card	Wait for  to stop flashing between each step.
	3 3 *	
	3 1 1 *	
►New [PIN] * New Card add another credential OR * to finish	
Add Toggle Credential	[Programming Code] * OR Programming Card	Wait for  to stop flashing between each step.
	3 3 *	
	1 9 1 *	
►New [PIN] * * (for PIN only) OR New Card add another credential OR * to finish	
Add Toggle +PIN Credential	[Programming Code] * OR Programming Card	Wait for  to stop flashing between each step.
	3 3 *	
	3 9 1 *	
►New [PIN] * New Card add another credential OR * to finish	

¹ Other lights may show before the final confirmation. Wait for final confirmation before continuing to the next step.

Function	Press/Present	Wait for confirmation ¹
Add Freeze Credential	[Programming Code] * OR Programming Card	Wait for  to stop flashing between each step.
	3 3 *	
	1 1 5 *	
▶ New [PIN] *	
	* (for PIN only) OR New Card add another credential OR * to finish	
Add Freeze +PIN Credential	[Programming Code] * OR Programming Card	Wait for  to stop flashing between each step.
	3 3 *	
	3 1 5 *	
▶ New [PIN] *	
	New Card add another credential OR * to finish	
Add Pass Through Credential	[Programming Code] * OR Programming Card	Wait for  to stop flashing between each step.
	3 3 *	
	1 1 9 *	
▶ New [PIN] *	
	* (for PIN only) OR New Card add another credential OR * to finish	
Add Pass Through +PIN Credential	[Programming Code] * OR Programming Card	Wait for  to stop flashing between each step.
	3 3 *	
	3 1 9 *	
▶ New [PIN] *	
	New Card add another credential OR * to finish	
Delete Credential	[Programming Code] * OR Programming Card	Wait for  to stop flashing between each step.
	5 *	
	Credential [PIN] * delete another credential OR * to finish	
Change Relock Time	[Programming Code] * OR Programming Card	Wait for  to stop flashing between each step.
	9 9 *	
	1 *	
	Each button press adds to the total delay time Example: 1 + 9 adds a 10 second delay	
	* to finish	
Disable/Enable Beeper	[Programming Code] *	Wait for  to stop flashing between each step.
	9 9 *	
	3 *	
	0 * to disable beeper OR 7 * to enable beeper	

¹ Other lights may show before the final confirmation. Wait for final confirmation before continuing to the next step.

Function	Press/Present	Wait for confirmation ¹
Change PIN Length	[Programming Code] * OR Programming Card	Wait for  to stop flashing between each step.
	9 9 *	
	4 *	
	Press ③, ④, ⑤, OR ⑥ for desired PIN length	
	* to finish	

¹ Other lights may show before the final confirmation. Wait for final confirmation before continuing to the next step.

Error codes

- ① **All error codes are indicated on the Schlage button by a solid red LED and a blinking green LED. The number of green blinks indicates the error code.**

Number of green blinks	Error Code Description
1	Computer programming error (not complete).
2	Too long programming/user code entered. Programming code must be five (5) digits. User code length cannot exceed six (6) digits.
3	Memory full, too many codes. Delete some codes.
4	Programming code cannot be deleted, only changed.
5	Programming code entries do not match. Programming code not changed.
6	Invalid command. Invalid function code entered.
7	Code not found.
8	Code too short. Programming code length must be five (5) digits. User code minimum length is three (3) digits.
9	Not a unique code.
10	Manual programming not allowed.

Error code functions have not been verified by Underwriters Laboratories Inc.

Test lock operation

If you encounter problems while performing any of the following tests, review the installation guide and correct any problems.

Mechanical test

1. Rotate the inside lever or depress the push bar to open the door. Operation should be smooth, and the latch should retract.
2. Insert the key into the keyway and rotate the key and the outside lever to open the door. Operation should be smooth, and the latch should retract. The Schlage button will light solid green until the key is released and the latch is extended.

Test in factory default mode

1. For locks with a keypad, press any number key. The lock will beep and the Schlage button will blink red.
2. The Schlage button will blink red twice when a credential is presented and the lock is in factory default mode, and has no access programming.
3. For locks with keypads, enter the default PIN (13579 and "#") to verify access. The Schlage button will blink green, a beep will sound, and the door will unlock for the preset relock delay period. After the relock delay period, the lock will relock and the Schlage button will blink red. If the lever retracts and holds the latch through the relock delay period, then the Schlage button will light green until the lever is released.

Test in normal operation mode

1. Present a valid credential. The Schlage button will blink green, a beep will sound and the door will unlock for the preset lock delay period. The lock will re-lock after the lock delay period and the Schlage button will then blink red. If the lever retracts and holds the latch through the relock delay period, then the Schlage button will light green until the lever is released.
2. If an invalid credential is presented, the Schlage button will blink red, a beep will sound and the door will not unlock.

Normal lock operation

After credentials have been programmed, present credentials to operate the lock as follows:

Credential type	Action
Credential	Present credential to reader → Green blink and access granted
+ PIN Credential	Present credential to reader → Press PIN ¹ → Within 5 seconds, Press # ² → Green blink and access granted

¹ If the PIN is entered incorrectly, press "*" to start over.

² The default PIN length is six (6) digits. The "#" key must be used as an ENTER key for PINs with fewer than six digits. PIN length can be configured using the SUS, so users do not have to press "#" key.

Reset to factory defaults

All information in the lock will be deleted and reset to factory defaults!

The door must be locked (not toggled open or in the middle of normal access) before resetting to factory defaults.

Level 1 factory default reset

- ① **Level 1 factory default reset will delete configurations and settings in the main controller in the lock.**
- ① **Main controller configurations that will reset to factory default include: programming and user codes.**
- ① **Level 1 factory default reset will not reset configurations and settings in the reader.**
 1. Press and hold the Schlage button. Wait for the lock to beep twice and two green blinks of the Schlage button, indicating confirmation.
 2. After confirmation signals, release the Schlage button.
 3. Rotate the mechanical key within 10 seconds and hold. The Schlage button will light green. Continue holding the key until confirmation signals are observed (the Schlage button light will turn off one second and a one second beep will sound). After confirmation signals, release the mechanical key.
 4. The Schlage button will light green for one second and a one-second beep will sound to confirm reset to factory defaults.
- ① **If the mechanical key is not rotated within 10 seconds, two beeps and two red blinks indicate timeout.**

Level 2 factory default reset

- ① **Level 2 factory default reset will delete all configurations and settings in the lock and the reader.**
- ① **Reader configurations that will reset to factory default include: keypad format, magstripe reader track, beeper on/off, and contactless card.**
- ① **Days in Use counter and lock type configurations will not reset.**

To complete Level 2 factory default reset, repeat steps 2 through 4 **within 10 seconds of the confirmation signals of level 1 factory default reset.**

If more than 10 seconds pass after the confirmation signals of level 1 reset, then level 1 reset must be repeated prior to performing level 2 reset.

Batteries

To install or replace alkaline batteries

- ① **Battery voltage can be checked with the SUS.**
- ① **Changing batteries does not affect any programmed data.**
 1. Remove the battery cover.
 2. Remove the battery bracket. **Do not allow the battery pack to hang from the wires.**
 3. Install the new batteries (install only new AA Alkaline batteries). Make sure the batteries are installed in the correct orientation.
 4. Reinstall the battery pack and battery bracket.
 5. Reinstall the battery cover, making sure the plug is to the right of the battery pack (CY, MS and MD locks). **Be careful not to pinch the battery wires when installing the battery cover.**
- ① **For coin cell battery installation or replacement, refer to instructions at www.schlage.com/support.**

CAUTION! Danger of explosion if batteries are incorrectly replaced! Replace only with the same or equivalent type. Dispose of used batteries according to the manufacturer's instructions.

This product has been evaluated for ULC-S319 compliance with Duracell Procell PC1500 AA alkaline batteries and Panasonic CR2025 lithium coin cell. For installations requiring ULC-S319, these battery models should be used.

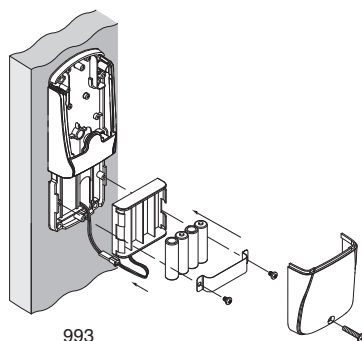
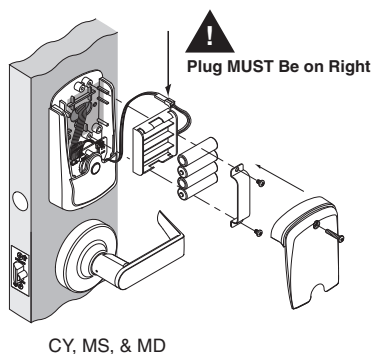

Low battery indications

Condition	Indicator	Solution
Batteries low	After credential is presented, 9 red blinks of Schlage button (Left = AA batteries, Right = Coin Cell battery), then normal indicator.	Replace batteries immediately to avoid battery failure. Lock is intended to operate for 500 cycles in low battery condition.
Battery Failure (configured by SUS)	No LED or beeps and valid credentials do not grant access	Replace batteries immediately. Mechanical override key must be used to unlock the lock.

Battery failure modes

- ① **The battery failure mode is set using the SUS. See the SUS user guide for more information.**

Mode	Description
Fail As-Is (default)	Lock remains in current state until batteries are replaced.
Fail Unlocked	Lock unlocks and remains unlocked until batteries are replaced.
Fail Locked	Lock locks and remains locked until batteries are replaced.

LED reference

Most LED indicators are configured with the SUS. See SUS user guide for more information.

Schlage button

Condition	Lights
Access denied	2 red blinks
Access denied, user outside time zone	4 red blinks
Factory default reset	One-second solid green with one-second beep
Waiting for PIN	5 left red with right green blinks, then solid right green
Low battery indicator, AA batteries	9 left red blinks
Low battery indicator, coin cell battery	9 right red blinks
Momentary unsecured access	1 green blink, then one red blink on relock
USB active with no physical connection	Left green blinking
An incompatible reader is on the lock	2 red blinks and 2 beeps with each card or key press, or 5 red blinks and 5 beeps on power-up

Optional Inside Push Button (IPB)

Action	Lights
Office Mode –Allows lock to toggle between locked (normal) and unlocked state	
Press IPB to lock	1 red blink
Press IPB to unlock ¹	1 green blink
Privacy Mode – Allows the lock to toggle between normal access and a state in which normal credentials are ignored	
With door closed, press IPB to engage privacy ²	4 green blinks
With door closed, press IPB to release privacy ³	4 red blinks

¹ Unlocking the lock with the IPB will cause the lock to remain unlocked until the IPB is depressed again.

² On locks configured with a mortise-deadbolt, throwing the deadbolt will also engage privacy.

³ If DPS is used, then opening door will also release privacy. If a mortise-deadbolt is used, then retracting the deadbolt will also release privacy.

Troubleshooting

Problem	Possible cause	Solution
The lock beeper does not sound and the keypad does not light when the Schlage button is pressed.	<p>The beeper may be turned off.</p> <p>The battery or wired power may be improperly connected.</p> <p>The batteries may be inserted with incorrect polarity.</p> <p>The reader may not be properly seated into the front escutcheon.</p> <p>The reader connector may have bent pins.</p> <p>The through-door cable may not be properly plugged in.</p>	<p>Use manual programming or the SUS to enable the beeper (see <i>Disable/Enable Beeper</i> on page 8 or the SUS user guide for more information)</p> <p>Check that the battery or wired power is connected correctly.</p> <p>Check that the batteries are inserted in the correct polarity.</p> <p>Check that the reader is fully seated into the front escutcheon.</p> <p>Check that there are no bent pins in the reader connector.</p> <p>Check that the through-door cable is plugged in correctly. The red wire should be on the left and not pinched in the door.</p> <p><i>Refer to the installation instructions that came with the CO-200 lock, or this user guide for details on the above mentioned procedures.</i></p>
The connection with the SUS is not successful.	The triangles on the outside lock assembly (cylindrical and mortise locks only) may not be properly aligned.	<p>Check the outside lock assembly (cylindrical and mortise locks only). The triangles on the back of the lock assembly must be properly aligned.</p> <p><i>Refer to the installation instructions that came with the CO-200 lock for details.</i></p>
The Schlage button is always on solid green.	The triangles on the outside lock assembly may not be properly aligned (cylindrical and mortise locks only).	<p>Check the outside lock assembly (cylindrical and mortise locks only). The triangles on the back of the lock assembly must be properly aligned.</p> <p><i>Refer to the installation instructions that came with the CO-200 lock</i></p>
<p>The reader is not working.</p> <p>The Smart card is not reading.</p> <p>The magnetic swipe card is not reading correctly (no beeps or blinks).</p>	<p>The through door cable may be pinched.</p> <p>The Smart card default of the card reader may not be correct for the Smart card.</p> <p>The “Mag Track in Use” default for all magnetic card credential readers is “Track2”. The magnetic swipe card data may be on Track1 or Track3.</p>	<p>Check that the through door cable is not pinched.</p> <p>Change the Smart card format using the SUS. Select CO-200 “Lock Properties”, “Reader” tab, and “Smart cards in use”.</p> <p>Use the SUS to change “Mag Track in Use”. Select CO-200 “Lock Properties”, “Reader” tab, and “MAG Card Track selection”.</p> <p><i>Refer to the installation instructions that came with the CO-200 lock, or the SUS user guide for details on the above mentioned procedures.</i></p>

Problem	Possible cause	Solution
The LEDs and beeper indicate an incompatible reader (2 red blinks and 2 beeps with each card or key press, or 5 red blinks and 5 beeps on power-up).	The reader is not the original reader matched with the lock at the factory.	The lock must be installed with the original reader that came with the lock.

Allegion Agency Statements

Compliance Statement (Part 15.19)

This device complies with Part 15 of the FCC Rules.

Operation is subject to the following two conditions:

1. This device may not cause harmful interference, and
2. This device must accept any interference received, including interference that may cause undesired operation.

Warning (Part 15.21)

Changes or modifications not expressly approved by the party responsible for compliance could void the user's authority to operate the equipment.

FCC Interference Statement (Part 15.105 (b))

This equipment has been tested and found to comply with the limits for a Class B digital device, pursuant to Part 15 of the FCC Rules. These limits are designed to provide reasonable protection against harmful interference in a residential installation. This equipment generates uses and can radiate radio frequency energy and, if not installed and used in accordance with the instructions, may cause harmful interference to radio communications. However, there is no guarantee that interference will not occur in a particular installation. If this equipment does cause harmful interference to radio or television reception, which can be determined by turning the equipment off and on, the user is encouraged to try to correct the interference by one of the following measures:

- Reorient or relocate the receiving antenna.
- Increase the separation between the equipment and receiver.
- Connect the equipment into an outlet on a circuit different from that to which the receiver is connected.
- Consult the dealer or an experienced radio/TV technician for help.

RF Exposure Statement

To comply with FCC/IC RF exposure requirements for mobile transmitting devices, this transmitter should only be used or installed at locations where there is at least 20 cm separation distance between the antenna and all persons.

Section 7.1.5 of RSS-GEN

Operation is subject to the following two conditions:

1. This device may not cause interference, and
2. This device must accept any interference, including interference that may cause undesired operation of the device.